

## Hermes Tension Screen User Manual

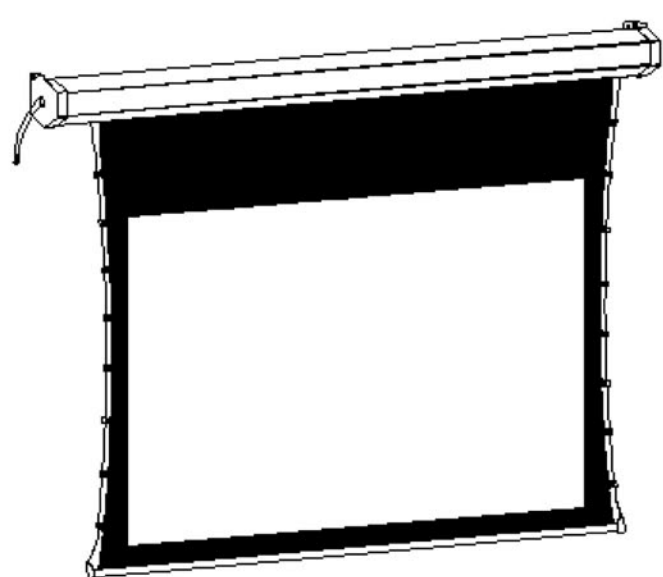

**Easy to use, Long life, Good picture quality.**  
Use with DLP / LCD projectors  
or overhead projectors for best results

Use a soft cloth or soft brush  
to clean the projection surface.

Use water and a soft  
cloth to clean the case.

**Note:** The screen may be operated as frequently as necessary but should not be lowered and raised continuously. Doing so will overheat the motor and power to cut off. If this happens it will be necessary to wait until the motor has cooled down sufficiently to resume operation.

### Installation Method

Install the screen in the location where the audience can see the whole screen when it is fully extended.

The screen can be wall mounting or ceiling hanging; users may choose the most suitable method according to their needs. Insure the right equipment is used for whichever chosen method.

#### Wall Mounting:

For mounting or hanging on the wall or on wooden surface ceiling, use  $\phi 5 \times 60$  mm screws.

For mounting or hanging on a brick, concrete or plaster surface, use  $\phi 6 \times 60$ mm screws with screw anchors or wall plugs.

Measure the distance from the holes in the wall mounting brackets, mark out the same distance on the wall and drill holes for the screws, and make sure that the holes are level. Screw an appropriate screw into each hole, hang the screen from the screws with the holes in the end cases. Check the screen whether it is evenly spaced from the wall with a spirit level.

### Wireless control unit operation (Fig. 7)

(Optional)

**To lower the projection surface** press the bottom button on the control unit, the projection surface will lower itself, when it is fully extended it will stop automatically.

**To retract the projection surface** press the top button on the control unit, the projection surface will retract into its case, when it is fully retracted it will stop automatically.

**To stop the projection surface** manually at an intermediate position, press the middle button on the control unit.

For detail remote control set-up, please refer to the individual remote Control manual

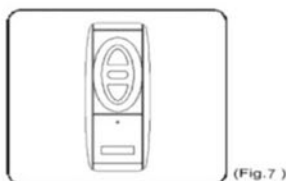

### Notice

#### Do not

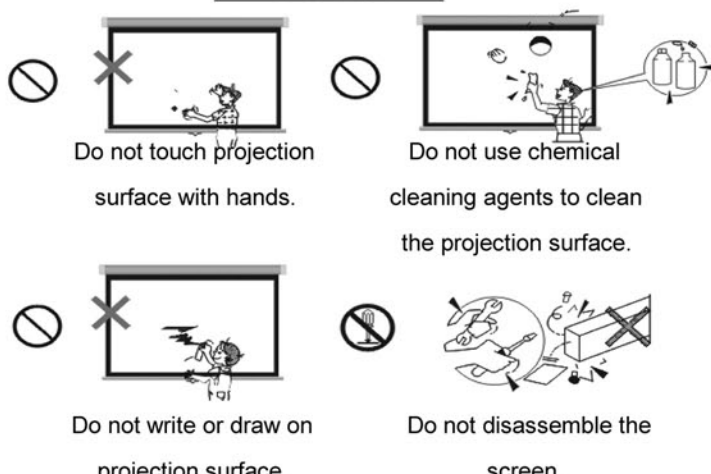

#### Correct

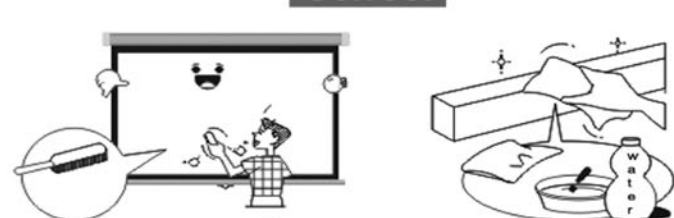

## SAFETY NOTICE



Misuse of the screen may cause damage to the screen or injury to persons.

**Warning**



To prevent damage to the screen and injury to persons, the screen must be mounted or hanged correctly and securely.

**Notice**



Do not hang things from the screen or climb on it. Doing so may cause the screen to fall off and damage the screen and cause injury.

**Do not hang from the screen**



Retract the projection surface back into the case after use. This will protect it from dust and dirt, and prevent it from loosening.

**Notice**



Do not disassemble the screen. Doing so may damage the screen and cause the screen fabric to fall down. If the screen needs repairing, contact the dealer from whom the screen was purchased.

**Do not disassemble**

Thank you for choosing our electric projection screen. Please read through this user manual before using the screen. Take care of the screen and do not misuse it.



### Warning Notice

1. Please remove the security screws at the back of the housing before installation. Otherwise motor & fabric will be damaged (Fig.1).

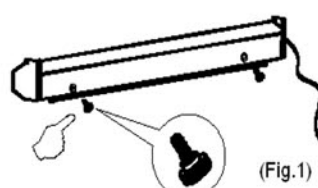

2. Insert the decoration covers into the holes (Fig.2).

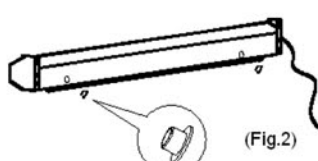

3. It is normal to see some uneven horizontal and vertical marks on the projection area after long period of storage. The marks could be disappeared gradually after the screen has been unrolled and hanged for a period of time.

4. Before installation of the projection screen on a wall or Ceiling hanging, please make sure that it could afford the weight of the screen.

5. Dust, dirt and scratches on the projection surface will affect the picture quality. For prevention, take notice of the points below:

- Do not touch the projection surface with hands.
- Do not write or draw on the projection surface.
- Do not use fingers or sharp objects to point on the projection surface as this will damage the screen fabric.
- Use a soft damp cloth to clean the projection surface only.
- Do not use chemical cleaning agents or alcohol.
- Use clean water.

#### Ceiling Hanging:

Measure the distance between the small holes at the top of the end-cap, drill holes for screw hooks with the same distance, and make sure the holes are in line with each other and parallel to the wall.

Screw the appropriate screw hooks into the holes and hang the screen. (Fig 8)

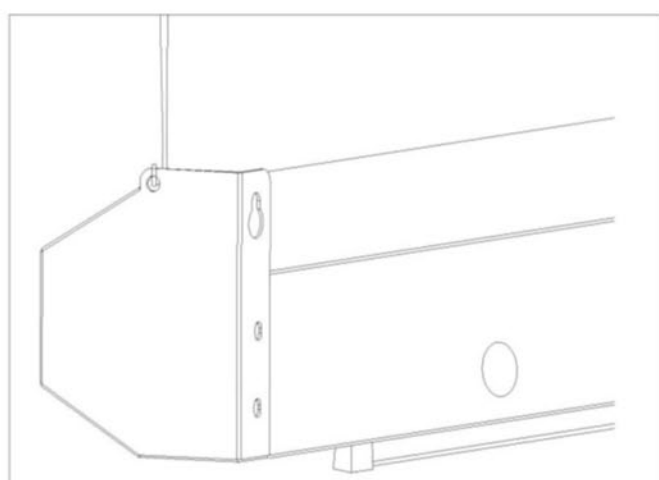

(Fig.8)

### Product Electrical Specification

Voltage: 100V~120V or 220V~240V

Frequency: 50Hz~60Hz

Power: 130W (MAX)

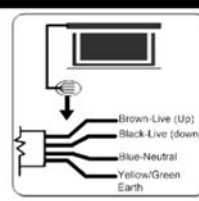

(Fig.3)

### Screen Operation

#### Wired control unit operation (Fig. 3)

Plug power cord into the main socket. (Make sure the correct voltage is supplied.) Position the cord so that it will not be tripped over, pulled or contact hot surfaces. If an extension cord is needed, then use the cord with the same current rating.

**To lower the projection surface** (Fig.5) toggle the switch to position < = >, the projection surface will lower itself, when it is fully extended it will stop automatically.

**To retract the projection surface** (Fig.6) toggle the switch to position < - >, the projection surface will retract into its case, when it is fully retracted it will stop automatically.

**To stop the projection surface** manually at an intermediate position, toggle the switch to the < O > position.

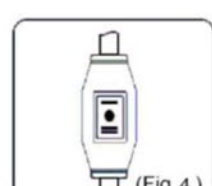

(Fig.4)

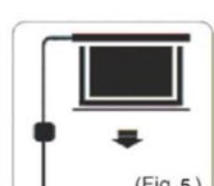

(Fig.5)

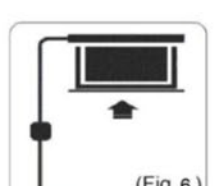

(Fig.6)

### Adjusting method

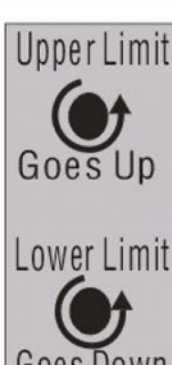

**Upper limit**—Adjust the stopping level of slat when fully retracted. Turn "upper limit" switch counterclockwise to let the slat go closer to the casing.

**Lower limit**—Adjust the stopping level of slat when fully extended. Turn "lower

limit" switch counterclockwise to let the slat go closer to the ground.

